



**Installation Guide**  
**BMW E9X M3**  
**TVS1740 Supercharger Kit**



## ATTENTION

**Installing the supercharger indicates your acceptance of the responsibility and liability associated with the fitment and use of this product. Please ensure the owner and drivers of the supercharged vehicle are aware of their responsibilities and liabilities as indicated below.**

Thank you for purchasing this supercharger which has been designed and made with pride. The owner and drivers of the enhanced vehicle must be aware that fitment of a supercharger may affect:

- The vehicle's factory warranty.
- Insurance cover and associated liabilities.
- Compatibility with emission and roadworthy certification.
- The validity of a driver's license for a supercharged vehicle.
- The handling and braking capability of the vehicle due to increased engine power & torque characteristics.
- The longevity of the engine.
- The vehicle will need to use premium unleaded fuel only.

It is the owner's/driver's responsibility to accept any consequences and liabilities of using the supercharger and any subsequent effect it may have. Harrop Engineering shall not be liable and shall be 'Held Harmless' for any direct and/or indirect/consequential losses, costs, damages, expenses, injuries or liabilities whatsoever incurred by the owner/driver of the vehicle or other parties arising from this supercharger, its installation and/or its operation.

It is recommended that vehicles have completed 1,500 km and have been driven, serviced and maintained in accordance with the vehicle manufacturer's handbook before fitting a supercharger. An engine should be deemed reliable and have delivered all reasonable expectations in line with the vehicle manufacturer's specifications prior to fitting a supercharger.



## Warranty

This supercharger is covered by a limited warranty on components and workmanship for a period of 12 months from the date of purchase, subject to the following:

- Installation must be completed by a qualified motor mechanic or technician who has undertaken appropriate training in fitting Harrop superchargers.
- The supercharger has not been modified or “overdriven” by fitting alternative drive pulleys.
- The supercharged vehicle has been tuned by an appropriately qualified and experienced technician.
- The supercharged vehicle has been driven in accordance with the conditions specified by the vehicle manufacturer’s normal use of operation, driving care and vehicle service program.
- The supercharged vehicle has not been used for competitive racing.

No warranty shall apply where Harrop have determined improper fitment or handling, misuse in operation, neglect, or accident damage. Engine modifications made prior to or in conjunction with the supercharger fitment may invalidate the Harrop limited warranty. Any warranty claims must be made immediately & directly in writing to Harrop Engineering so that a determination can be made promptly. Involvement of a third party or an attempt to repair a perceived/actual fault may invalidate the warranty. To the extent of the law, the determination on any warranty claim & associated costs will be at the sole discretion of Harrop Engineering.

**By installing the supercharger you acknowledge that all conditions pertaining to this supercharger and its operation have been read, understood and accepted.**

## Quick-start guide for experienced Automotive Technicians

This document is meant only as a guide, as any vehicle modification should be completed by a certified technician who has the relevant experience and equipment to be competent of a safe and effective supercharger installation.

**Please ensure the safe operation of all tools and equipment are adhered to in accordance with the vehicle and equipment manufacture's recommendation.**

1. Ensure the vehicle is prepared with premium unleaded fuel.
2. Disconnect the negative terminal of the battery.
3. Avoid inverting the supercharger assembly or stand it on end, as the oil in the gear housing may migrate from the intended area.
4. Remove the airbox.
  - 4.a. Disconnect the quick connect breather hose from the intake duct.
  - 4.b. Remove the 2 hose clamps securing the intake duct.
  - 4.c. Remove the 2 bolts holding the air box.



4.d. Lift the air box up off two grommets to remove it from the engine bay.



## 5. Remove upper ancillaries.

5.a. Pull off rubber seal from the top of the engine bay.

5.b. Remove the 6 bolts securing the fresh air filters on both sides of the car.



5.c. Remove the left side from the car. Disconnect the alarm loom from the right side and remove the cover from the vehicle.

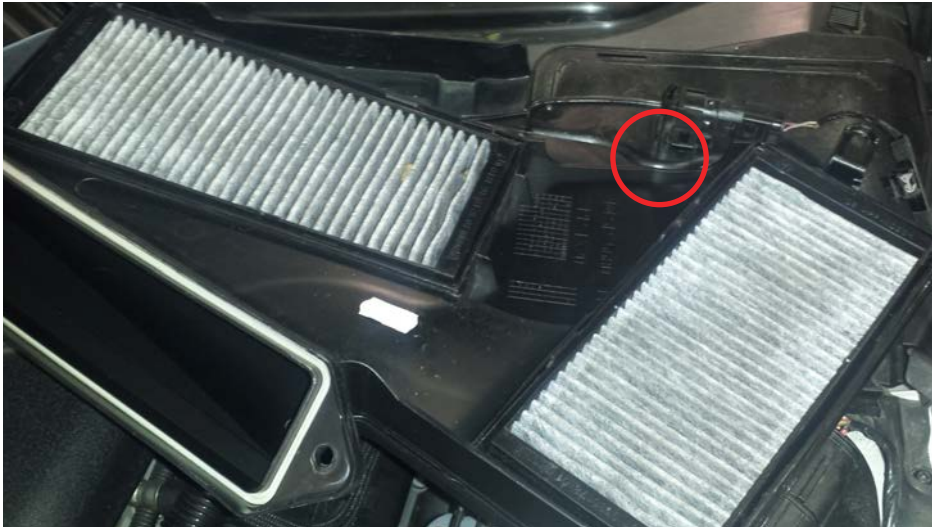

5.d. Remove the 3 bolts securing the loom harness. (Found on right hand drive built cars)

5.e. Remove the rear plastic cover; remove 1 bolt and unclip 2 rubber tabs holding it in place on each side. Carefully lift the cover out.

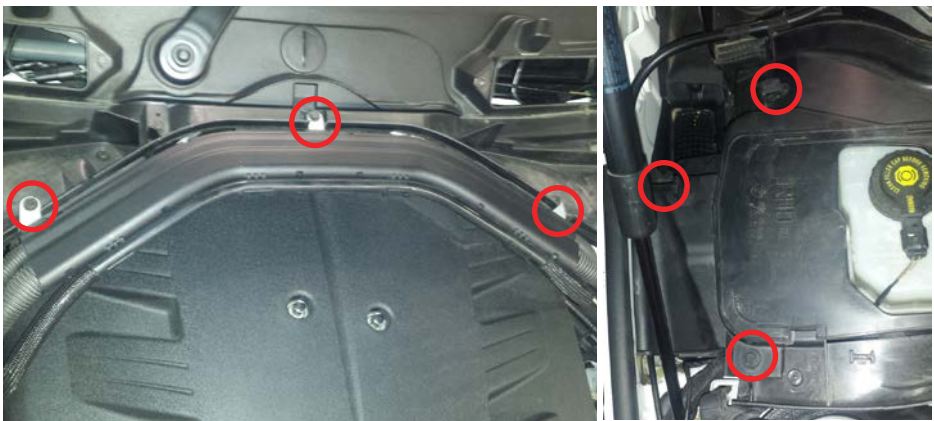

5.f. Remove the nut supporting the wiring harness on the right hand side strut brace.  
Remove the 4 bolts securing the strut braces on both sides, remove strut braces.



## 6. Manifold removal

6.a. Disconnect intake air temp sensor.



6.b. Loosen the 8 hose clamps securing the manifold in place on the throttle bodies.

6.c. Disconnect the vent hose from underneath the manifold intake mouth.

6.d. Disconnect the breather hose from the left hand rear of the manifold.

6.e. Lift and remove the manifold off the throttle bodies.

## 7. Disconnect the injectors by depressing the wire clips.

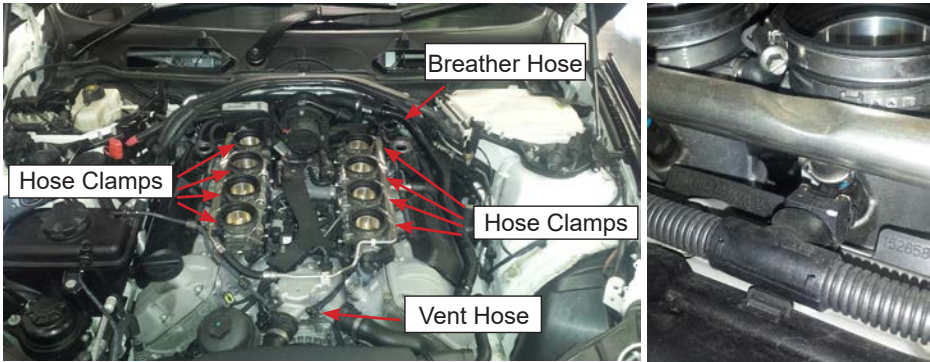

7.a. Remove the 4 torx bolts holding the fuel rails, bolts will not be reused.

Remove the fuel rails and injectors. Lay them on top of the throttle bodies.

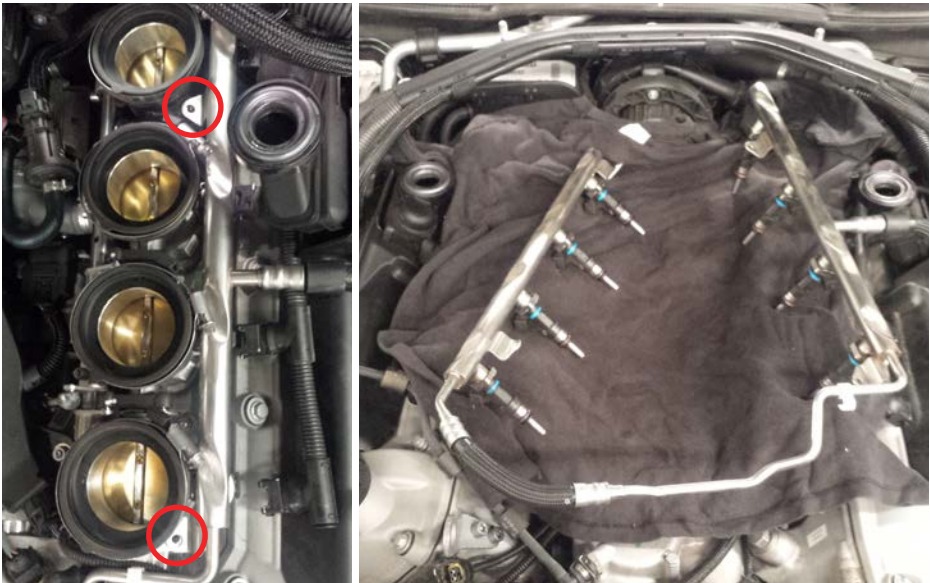

7.b. Remove the injector clips and injectors from fuel rails.

**Caution: Use eye protection when removing injectors. The system is still pressurized and may squirt fuel as the first injector is removed. Use a suitable method to collect fuel.**

Lubricate o-rings on new injectors and install into fuel rails. Secure injectors with factory clips.



Note: check injectors and clips are completely seated into fuel rails.



1.a. Fit the fuel rails ensuring the injectors are correctly seated in the throttle bodies.

1.b. Install the supplied supercharger mounts to the fuel rail bolt positions using the 4 M6x50 socket head cap screw supplied. Use the aluminium aligning plate provided to ensure these mounts are at 90 degrees to the crank centerline and torque to 12Nm.



7.e. Reconnect the injector loom ensuring the spring clips snap in place.  
7.f. Relocate the electrical connector / loom from the location shown in green to the location shown in red. Secure in place with a cable tie.

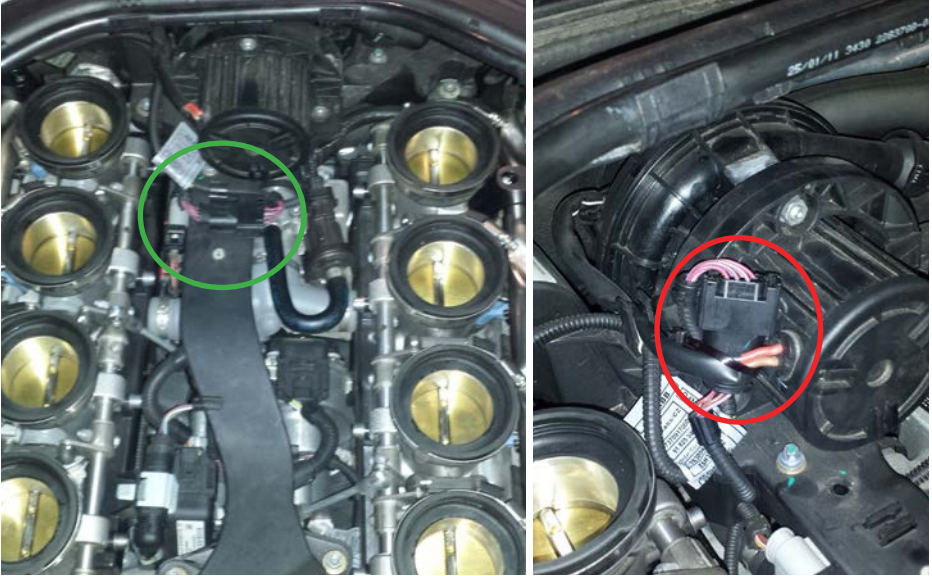

7.g. Remove the standard purge line from manifold vacuum to the purge solenoid, remove the solenoid mount.

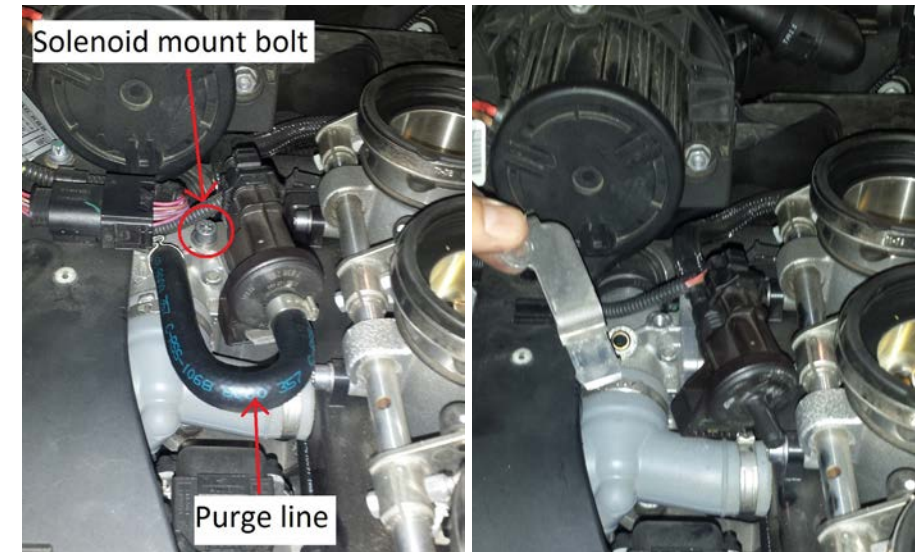

7.h. Install the replacement solenoid mount in the position shown below. (Torx bolt through the idle circuit manifold)  
Fit the solenoid to the mount.

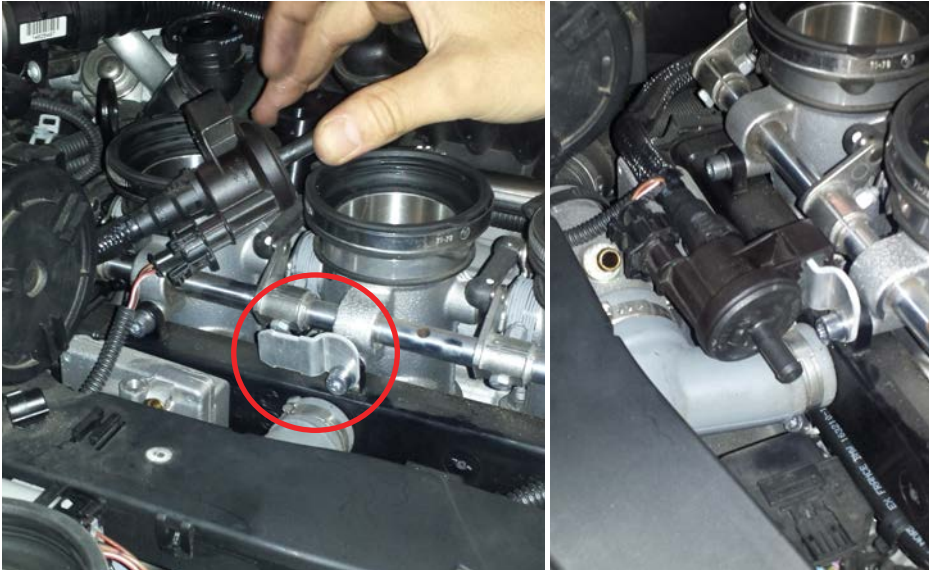

7.i. Use the supplied zip tie to secure the purge solenoid to the mounting bracket.

7.j. Install the supplied one-way valve / purge line as shown below with 12mm hose clamps at both ends.



7.k. Remove the 45 degree quick connect fitting from the idle air circuit line (rear L/H side) and replace with the supplied 90 degree quick connect fitting.



7.l. Remove the engine lifting bracket from the front R/H side of the engine, shown in green, this will not be refitted (2 x 8mm torx bolts). The breather line located at the front L/H side of the engine requires shortening (shown in red below). Trim 75mm off the end of this hose.

7.m. Install the 8mm ID by 120 long rubber hose that is supplied in the supercharger install kit on to the plastic breather hose.



## 8. Supercharger assembly

8.a. Release any pressure in the engine cooling system by removing and refitting the coolant cap.

8.b. Remove the 3 bolts from the top of the thermostat housing, best to perform this operation on a cold engine as coolant may leak from the housing (these bolts will not be reused).

8.c. Install the supplied supercharger / FEAD mount in position shown, install the 3 supplied bolts (socket head bolt circled in green) tighten these bolts finger tight and push the mount to the rear.



**Ensure that the 8 manifold hose clamps are oriented correctly and are loose enough to accept the manifold.**

8.d. Temporarily install the supercharger assembly (this will be installed to set the position of the supercharger / FEAD mount and then removed to torque the remaining bolts). Ensure the throttle body rubbers and the undersides of the supercharger are clean. (Be sure to lift the supercharger assembly into position. Do not slide the assembly over the rubber boots as this may damage or fold them.)

8.e. Once the assembly is in place it should sit on the four mounts installed on the fuel rails. At this stage install 4 x M6 cap screws and flat washers into these mounts and tighten to 12 Nm.



M6 Cap screws  
to Supercharger  
mounts

M6 Cap screws  
to Supercharger  
mounts

8.f. Install the FEAD assembly to the front of the supercharger / mount, tighten 6 x M8 cap screws. The 20mm long cap screws are installed into the supercharger front cover and the 30mm long cap screws are installed into the FEAD mount. (This aligns the FEAD mount into its correct position.)



M8x20mm SH  
Cap screws

M8x30mm SH  
Cap screws

8.g. Using a 10mm ratchet spanner, tighten the L/H and rear bolt (show in green) on the supercharger FEAD mount (this will hold the mount in the correct position so it can be torqued when the supercharger is removed. (Supercharger omitted for clarity.)

---



8.h. Remove the FEAD assembly (6 by M8 cap screws, be careful not to move the above supercharger FEAD mount)

8.i. Remove the 4 by M6 cap screws from the fuel rail supercharger mounts.

8.j. Remove the supercharger assembly.

8.k. Torque 3 by M6 bolts in the supercharger mount to 14Nm.

## 9. Supercharger final assembly

9.a. Install the rear intercooler lines. Connect the 670 long 16mm hose to the rear left intercooler fitting, connect the 330 long 16mm hose to the rear right intercooler fitting, secure with cobra clamps (black band) from the intercooler kit.

---



9.b. Install the 860 long molded 16mm hose to the front left hand intercooler fitting using the supplied cobra clamp (21mm green band) this line runs under the front intake of the supercharger assembly.



9.c. Install the supercharger assembly. Ensure the throttle body rubbers and the undersides of the supercharger are clean. (Be sure to lift the supercharger assembly into position. Do not slide the assembly over the rubber boots as this may damage or fold them) Before lowering the assembly fully connect the breather line at the front of the engine (Step 4n) to the fitting on the underside of the supercharger inlet.





9.d. Lower the supercharger assembly into position checking the routing of the L/H intercooler line is as shown below, ensure its clear of the throttle linkage on the R/H front throttle body.



9.e. Visually check that the rubber throttle body boots are in the correct position and are not folded.

9.f. Install and torque (14Nm) 4 x M6 cap screws into the fuel rail supercharger mounts.

9.g. Torque the 8 hose clamps on the rubber throttle body boots to 5Nm.



9.h. Install the FEAD assembly as previous and torque to 22Nm.



9.i. Connect the short molded 16mm hose to the front R/H intercooler fitting using the supplied cobra clamp. (21mm green band)



9.j. Remove the IAT sensor from the front R/H side of the standard manifold and install it into the front R/H side of the supercharger manifold. Using the supplied loom extension connect the IAT sensor to the engine harness.



9.k. Connect the newly fitted 90 degree quick connect on the idle air circuit hose to the rear L/H side of the supercharger manifold.



9.l. Install the supplied valve cover molded breather hoses to the valve covers / supercharger inlet as shown below. Secure with 4 cobra clamps (black band).

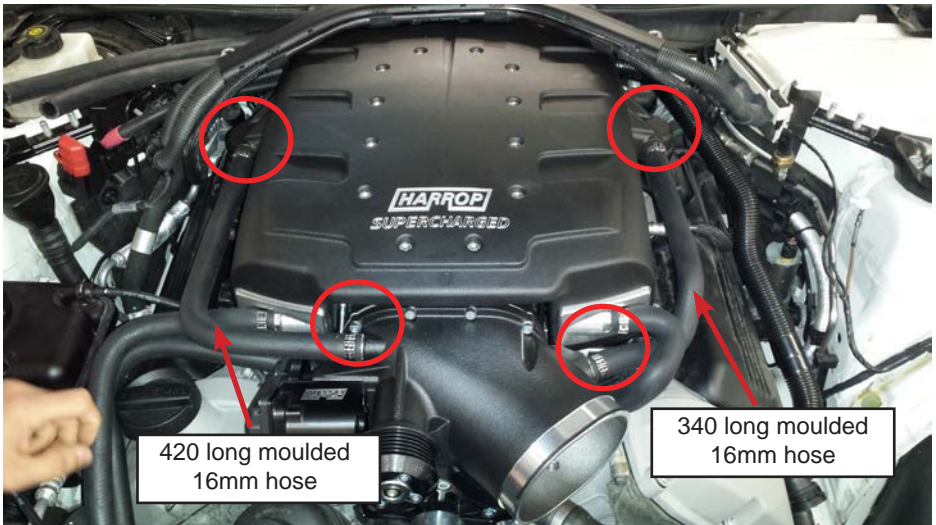

**10. Remove the radiator fan assembly**

10.a. Remove the air duct from above the radiator fan, 2 torx bolts.

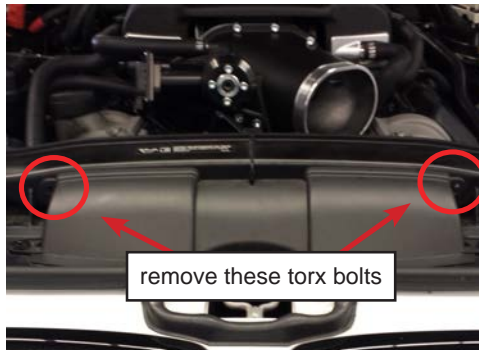

- 10.b. Unclip the engine coolant vent line from the top of the fan.
- 10.c. Disconnect the fan loom connector.
- 10.d. Remove the torx bolt securing the fan at the top R/H side
- 10.e. Lift the fan assembly out of the engine bay.



## 11. Belt installation / route

- 11.a. Remove the front accessory belt (there are plastic covers over the hex bolt on the tensioners) see below for tensioner locations.

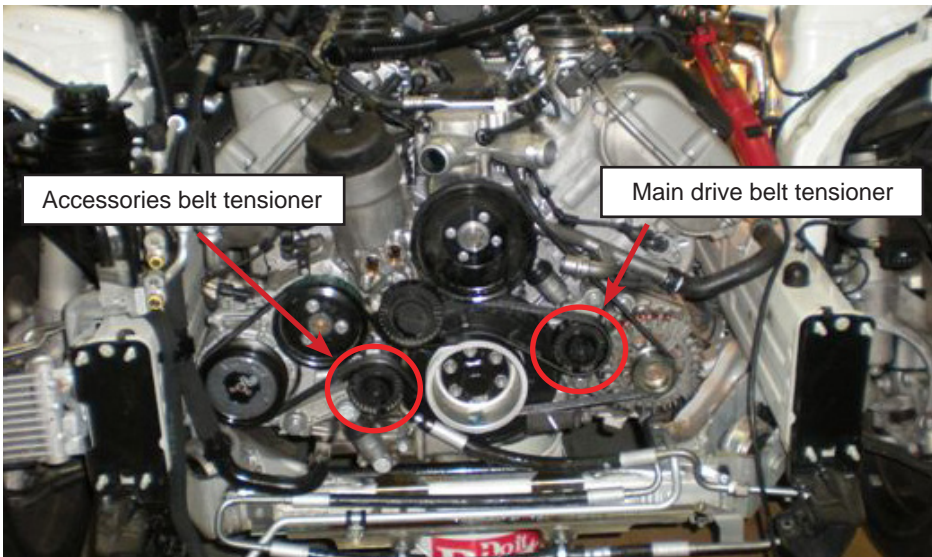

Accessories belt routing for cars produced before 06/2008 with single sided groove belt for air conditioning and power steering pumps.

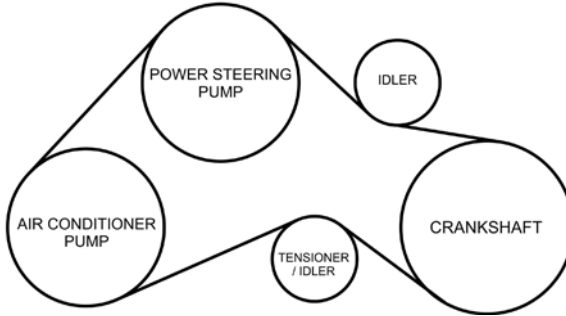

Accessories belt routing for cars produced after 06/2008 with double sided groove belt for air conditioning and power steering pumps.

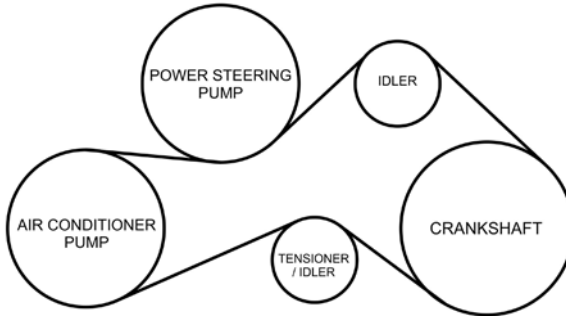

11.b. Remove the main drive belt (this requires removal of the idler pulley next to the water pump pulley).

11.c. Install the new drive belt in the route shown below.

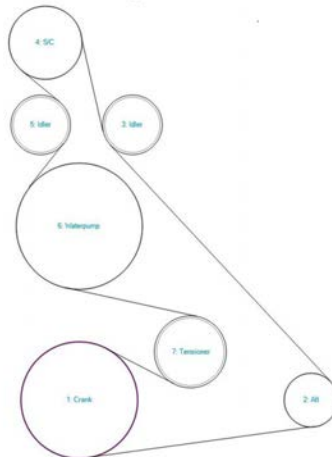

## 12. Intercooler system installation

---

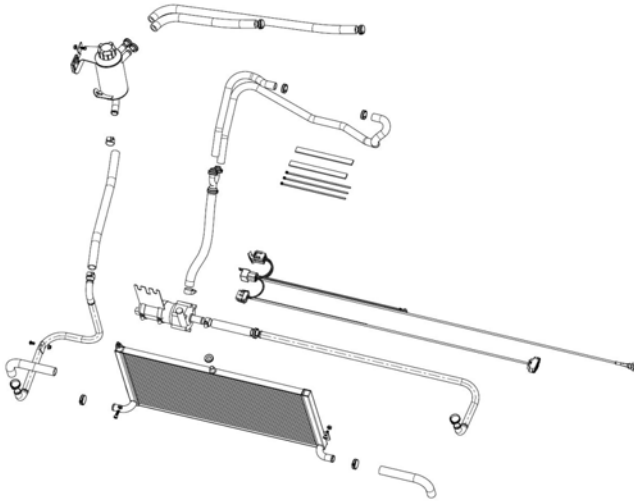

- 
- 12.a. Place vehicle on hoist and remove front the wheels.  
12.b. Remove both front guard liners.
- 



12.c. Remove the front bar. 1 hanger either side, 2 x bolts inside the guards either side 3 bolts on the thrust plate underneath and 4 bolts on top of the grill. Take note to disconnect the 4 parking sensors as you lift the front bar off.



12.d. Remove the air duct from above the radiator. Remove the 2 scrivets and lift the duct off.





12.e. Remove the 3 torx bolts securing the bonnet catch and rubber grill surround. Unclip the rubber grill surround and remove together.

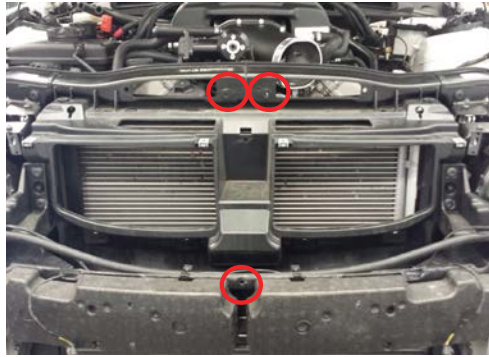

12.f. A 20mm hole is to be drilled in the hood latch recess for mounting the intercooler radiator. Drill the hole 22.5mm from the back face, centered left to right (as shown below). Insert the supplied rubber grommet into the hole.



12.g. Remove the oil cooler mounting bolts, 2 on the R/H side, 1 on the L/H side. The oil cooler will hang down and allow access for installing the intercooler radiator.



12.h. Install the intercooler radiator by sliding it up from under the vehicle until the pin is fully inserted in the grommet installed previously. The bleeder nipple should be on the R/H side of the car.



12.i. Holding the intercooler radiator up, use the brackets on the left and right sides of the radiator as a guide to drill 6mm holes through the plastic support panel behind ( be sure that there are no lines / looms in this position and do not drill through into the AC condenser)

12.j. Install the supplied M6 cap screws from the front and flange nuts from behind the support panel to secure the radiator.

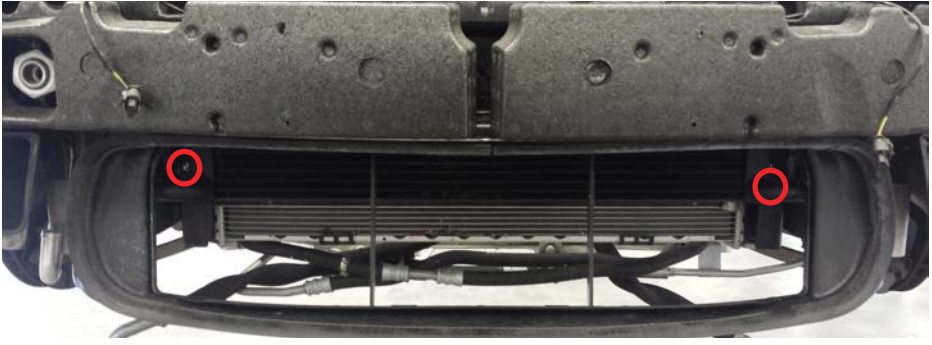

12.k. Install intercooler pipe to the R/H side of the intercooler radiator using the supplied M6 button head / flange nut.



12.l. Loosen the 2 nuts above and the 2 nuts below on the R/H side of the radiator that mount the radiator support panel to the sub frame.



12.m. Assemble the intercooler pump onto the pump bracket with the outlet pointing upwards as shown below. Slide it up between the end of the chassis rail and the radiator support panel until the slots bottom out on the radiator support panel studs. Once the pump assembly is in position re-tighten the 4 radiator support panel nuts.

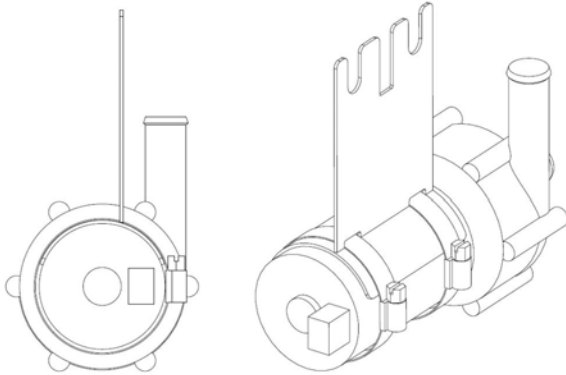

12.n. Fit the 2 short 90 degree 19mm bend hoses to the front of the intercooler, long ends on intercooler short ends pointing down. Secure with cobra clamps (white band).



12.o. Install the 900mm long intercooler pipe to the L/H side of the intercooler radiator hose using the supplied cobra clamp (white band).



12.p. Install the 125 long 19mm hose to the straight end of the long intercooler pipe using a cobra clamp (white band).

12.q. Connect intercooler pipe (running from the L/H side of the vehicle) to the center (inlet) on the intercooler pump using the supplied worm drive clamp.

12.r.



12.s. Install the black “Y” fitting into the front intercooler hoses on the supercharger manifold (21mm green band cobra clamps). Install the 420 long 19mm hose to the other end of the “Y” piece fitting and secure with a cobra clamp (white band).

12.t. Connect pump outlet to other end of 420 long 19mm hose using the supplied worm drive clamp.



Worm drive clamp

12.v. Located in the engine bay on the R/H strut tower is the window washer filler. Remove this from its mount and move it forwards.

12.w. Remove the M6 flange nut on a body stud / earth on the inside of the strut tower. Install the intercooler reservoir in the location shown below and reinstall the flange nut over the lower reservoir bracket. The top reservoir bracket fits into the original filler mount location and is secured with the supplied M6 bolt and flange nut. Once the reservoir is installed clip the washer filler to the bracket on the reservoir bottle.



12.x. Install 390 long 19mm intercooler hose between the lower fitting on the reservoir bottle and intercooler pipe running to the right hand side of the intercooler radiator. Fit the supplied worm drive clamps both ends.

12.y. Connect the intercooler hoses from the rear of the manifold intercoolers to the 2 fittings on the intercooler reservoir using the supplied cobra clamps (black band). The cross brace has been used to check the routing of looms in this area.



### 13. M3 bypass – I/C pump wiring

Bypass controller / Intercooler pump loom



Red – 12V constant supply  
Black – Earth  
Grey – Switched 12V supply  
White – Input 1  
Blue – Input 2



13.a. Locate and remove the cover to the white sealed box housing the digital motor electronics (DME).  
(RH drive model shown)



**13.b. Red – 12v constant supply.**

Connect this wire to the solid red 12v supply on the underside of the orange relay located in the front of the DME box. Unplug the relay, remove the terminal from the relay housing. Strip a 10mm section off the wire approximately 50mm from the terminal and solder the red wire on. Cover the soldered section with heat shrink, reinstall the terminal and reconnect the relay.



### 13.c. Black – Earth

Run the black earth wire along the path shown in green below. Connect this wire to the 6mm stud located on the inside of the strut tower using the supplied M6 nut.

Cable tie in place.

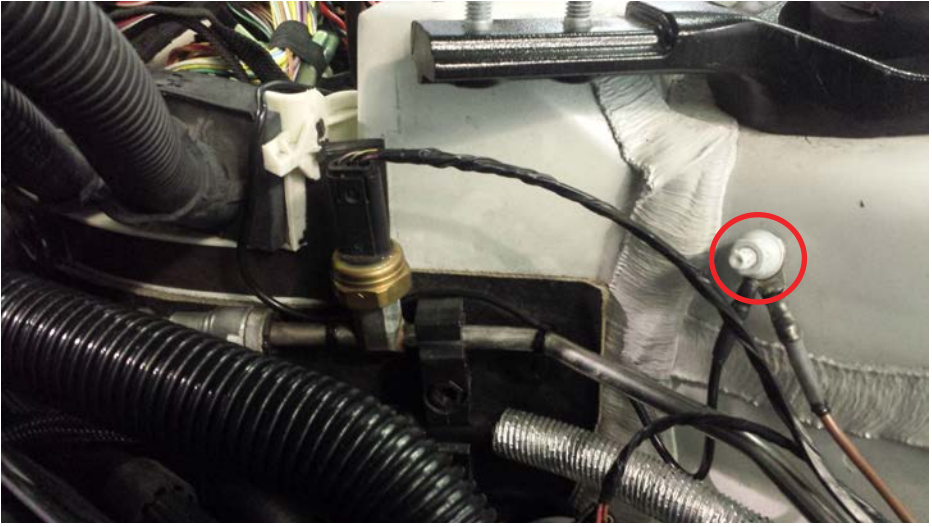

### 13.d. Grey – 12v switched

Connect the grey wire to the white with red trace wire in the white connector at the back of the DME box. Unplug the connector, remove the terminal from its housing. Strip a 10mm section off the wire approximately 50mm from the terminal and solder the grey wire on. Cover the soldered section with heat shrink, reinstall the terminal to the housing and reconnect the plug.

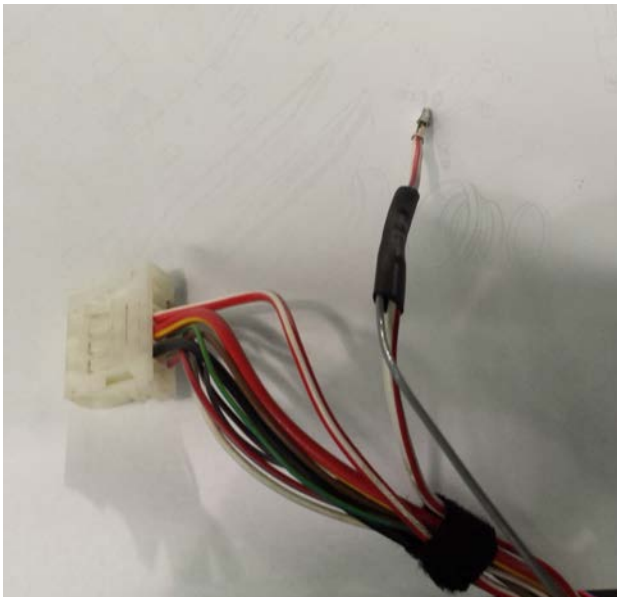
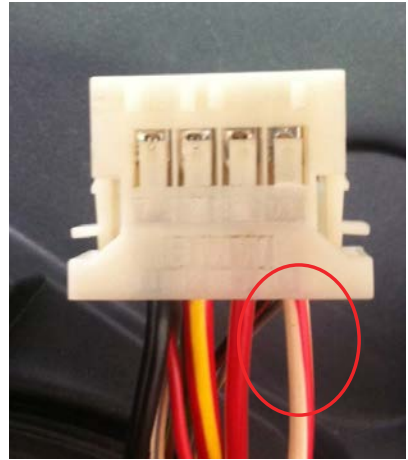
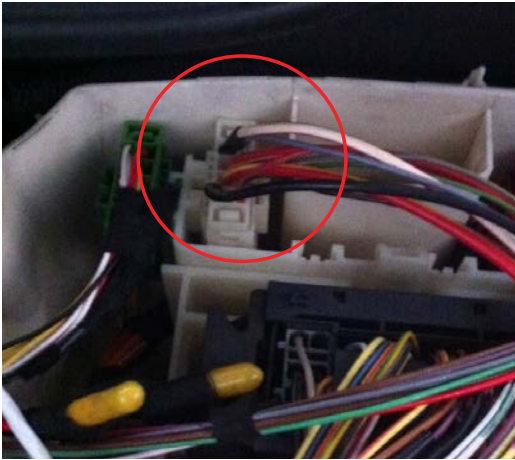

### 13.e. White – Input 1

Connect the white wire to pin 37 on the main DME connector.

- Locate pin 37 (the back row of pins, 15 PINS (not wires) from the left hand side of the connector, purple wire with white trace)

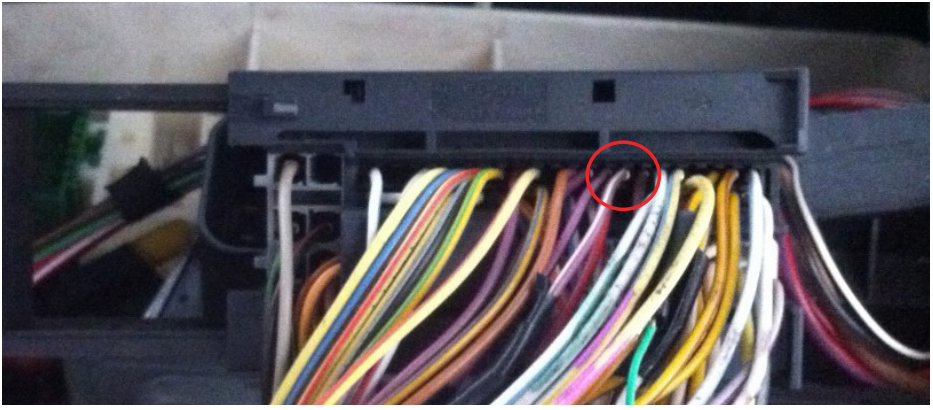

- Slide the locking mechanism for the main connector out.

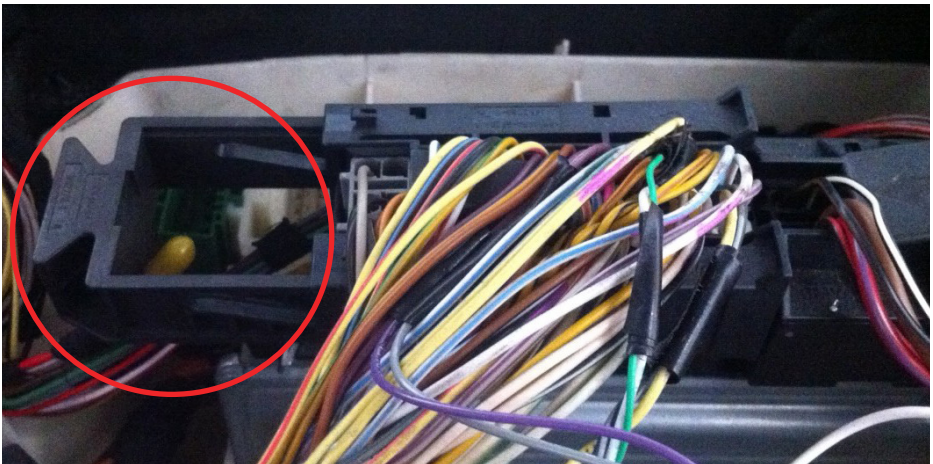

- Remove the main connector from the DME and slide the black sub connector from its housing (lever the locking tab to get the connector out).

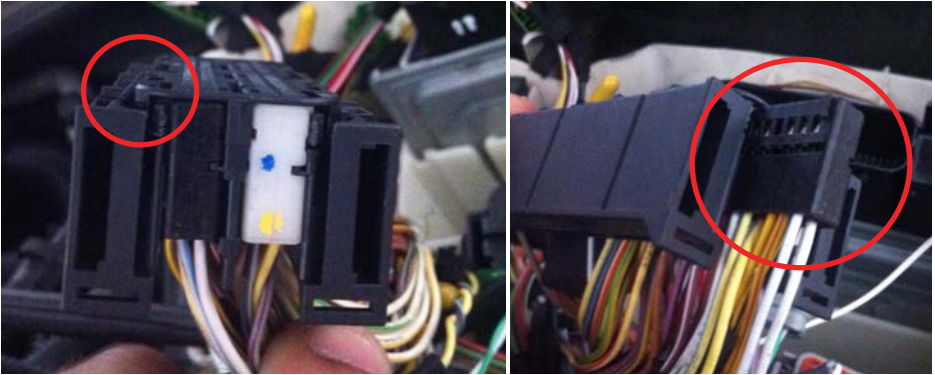

- Remove the wire located in pin 37 from the sub connector. Strip 10mm of insulation off the wire 50mm back from the pin.
- Solder the white TPS signal wire to the pin 37 wire where the insulation has been stripped.
- Slide heat shrink over the joint and seal.
- Reinstall the terminal and then reinstall the connector.

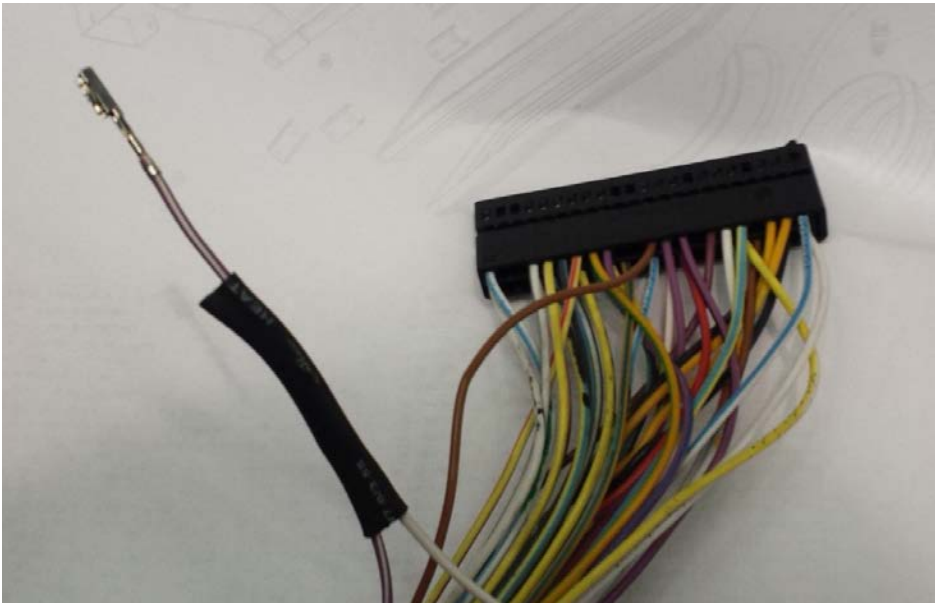

### 13.f. Blue – Input 2

Connect the blue wire with white trace to pin 20 on the small plug for the DME connector.

- Locate pin 20 (the back row of pins, 7 PINS (not wires) from the left hand side of the connector, white wire)
- Remove the main connector from the DME and slide the black sub connector from its housing (lever the locking tab to get the connector out)

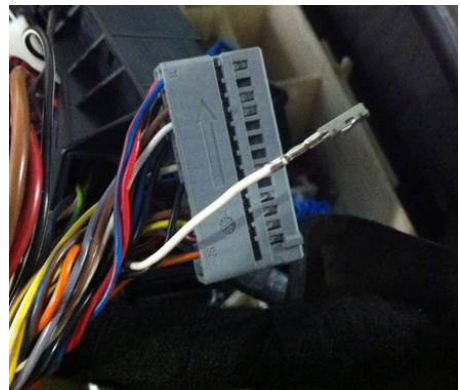
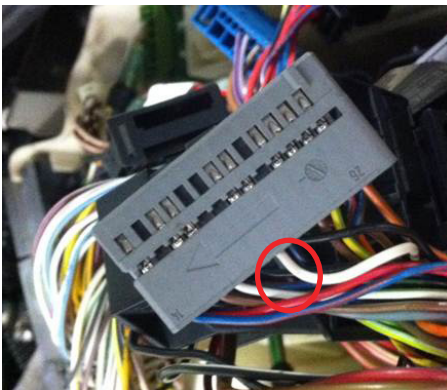

- Solder the Blue DME signal wire to the pin 20 wire where the insulation has been stripped.
- Slide heat shrink over the joint and seal.
- Reinstall the terminal and then reinstall the connector.

### **13.g. Cable routing to the intercooler pump and bypass motor**

Run the bypass controller and intercooler pump wiring behind the back of the manifold on top of the intercooler hoses. At the rear right hand side split the two looms. Run the bypass controller loom down along the valley of the engine to the bypass motor and plug it in. Run the intercooler down the right hand side of the engine bay under the intercooler reservoir to the intercooler



pump. Cable tie the looms as required.

**13.h.** Connect the bypass controller box to the connector on the loom and place in the DME box. (Note some fully optioned vehicles will not have a spare cavity in the DME box. On these vehicles it will be necessary to relocate the orange and green relays within the box and this front cavity used to house the bypass controller).

**13.i.** Reinstall the cover to the DME box.

**13.j.** Connect battery.



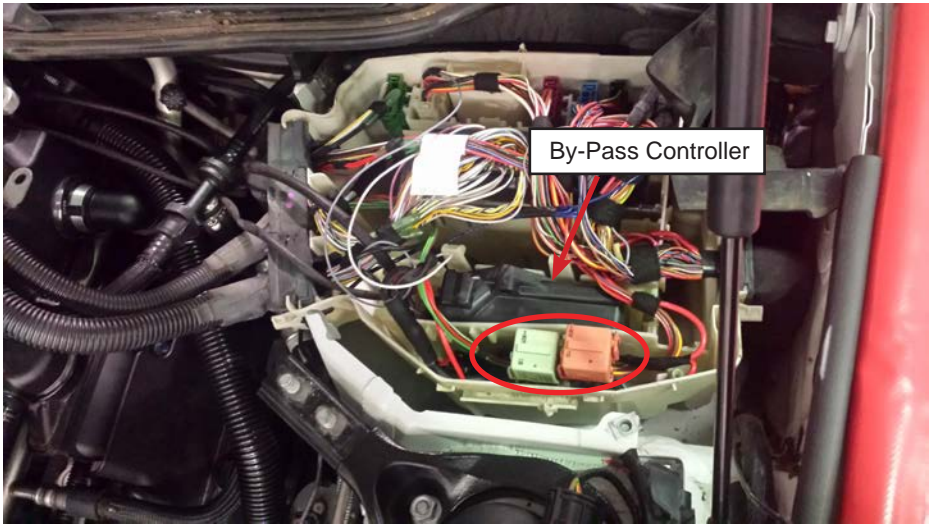

## 14. Coolant

14.a. Fill the intercooler reservoir with BMW recommended cooling system coolant. Open the bleeder valve on the top of the intercooler radiator to allow air to purge from the system. Close the bleeder valve and switch the ignition on without running the engine, the intercooler pump will start and you will see flow in the reservoir. Repeat the process until there is no air in the system and the return flow to the reservoir is constant.



15. Reinstall hood latch and inner grill surround.



16. Reinstall fan assembly.

17. Reinstall front bar.

18. Reinstall the front guard liners.

19. Reinstall the air box ducting on top of the radiator and on top of the fan assembly.

**20. Airbox / duct install**

20.a. Remove the upper airbox, filter and plastic inlet tube.

20.b. Reinstall the lower airbox (sitting on the rubber mounts under the airbox -no bolts at this stage).

20.c. Install the new rubber supercharger clean air duct to the supercharger.

20.d. Install the standard plastic filter adaptor into the rubber clean air duct.

20.e. Install the filter

20.f. Install 2 x M6 bolts to the L/H side of the airbox and check fitment.

20.g. Reinstall the upper airbox.

20.h. Connect front breather hose 45 degree quick connect to fitting in rubber clean air duct.



**21.** Re-install all ancillary components that were removed during the supercharger installation (strut braces, accessories cover, fresh air filters etc).

## First startup checks

**22.** Check that the drive belt fitted is free from debris, oil and coolant residue. Clean if necessary.

**23.** Re-checking all electrical, fuel, vacuum, duct, coolant and intercooler connections.

**24.** Without starting the engine, turn the key to ignition and check for fuel and intercooler coolant leaks.

**24.a.** As the fuel pump will only operate for a few seconds without the engine running, it may be necessary to repeat the process several times.

**25.** Load a tune into the vehicle's DME, see separate tune installation section.

**26.** When satisfied that there are no fuel or coolant leaks, start the engine and re-check for leaks, alignment or interference with *moving parts*.

**26.a.** Take specific care to check;

26.a.01. The fuel injectors for leaks

26.a.02. The PCV and idle circuit lines

26.a.03. The drive belt alignment

26.a.04. The intercooler coolant level

26.a.05. Engine coolant leaks under the front supercharger mount (step 5I).

**26.b.** After the engine has been at operating temperature, let it cool and re-check as above.

**26.c.** Repeat the above process until the system is secure, aligned and leak-free.

# BMW E9X MSS60

## Harrop-Flash

### Installation





This guide is to install and run the Harrop-Flash software required for BMW M3 supercharger calibration.

#### Required

- Supplied Harrop-Flash module, USB cable, USB drive
- Notebook (windows XP, 7, 8, 8.1) 32 or 64 bit OS

#### 1. Email vehicle VIN to sales@harrop.com.au

Harrop will reply email with 3 files – please save these files to your desktop;

- Harrop Flash Software – This file is the software to manage calibrations
- Stock BMW calibration (harrop\_bmw\_mss60\_240eek)– This file is an updated stock file
- Supercharged calibration (harrop\_mss60\_supercharger\_xxx-xxx)– This file is the final supercharged calibration which is loaded after the updated stock file is loaded.

#### 2. Run and install the software Harrop-Flash\_bmw\_installation.exe

(If using a Windows 8 or 8.1 machine refer to the back page of the manual for instruction on driver installation)

This will install the software to flash the factory BMW DME and also allow the user to read and clear diagnostics.

3. Copy the directory from the USB drive to your desktop
4. After installation you are ready to install the vehicle calibration.

It is advisable to have a battery charger connected to the vehicle and notebook while flashing the DME, this will insure there is no loss of power during the software installation.

5. Connect the USB cable to the Harrop-Flash device.
6. Connect the USB cable to a USB port on your notebook
7. Connect the Harrop-Flash device to the OBD 2 port on the vehicle



8. Push the ignition button once for accessories on and a second time for ignition on (engine light on, no engine running)

## 9. Start the Harrop-Flash software

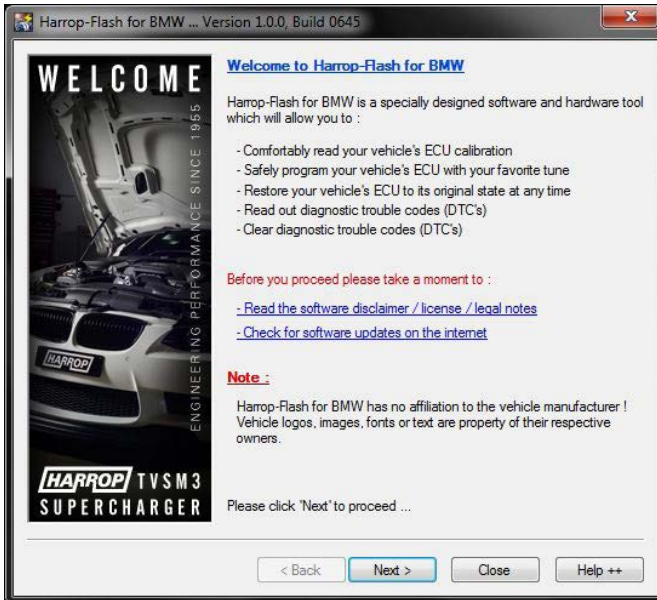

- Click next

## 10. The software will check the notebook speed and battery level



- Click next



# 11. Read the displayed information regarding notebook and vehicle power.



- Click next

# 12. The software will connect to the vehicle and ID the DME and VIN. Read the displayed information. This step will code the Harrop-Flash device to your vehicle.

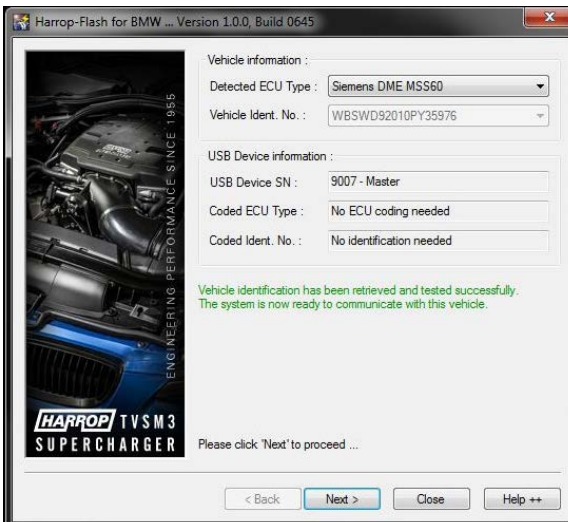

- Click next

#### 14. Click write ECU Memory

- First we will write standard updated factory software 240E to the vehicle
- Choose the file “harrop\_bmw\_mss60\_240eek” from the copied folder on your desktop and press open. This will start the write process to the DME and will take approximately 5 minutes



- #### 15. Once complete turn the ignition off and click ignition off on in the software



- Wait for the timer to finish

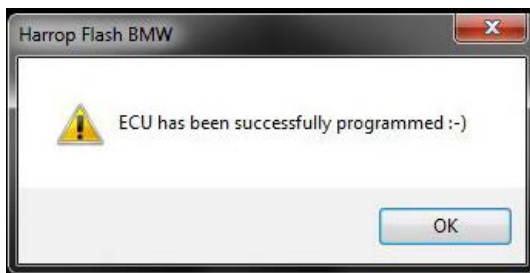

16. Exit the software.

17. Press the ignition button twice (engine light on without starting the vehicle) and restart the Harrop-Flash software.

- Follow the same procedure as previous but this time at the write ECU Memory (step 12) choose the supercharger calibration file “harrop\_mss60\_supercharger\_xxx-xxx” located in the copied folder on your desktop.

- This will write the supercharger calibration file to the vehicles DME.

- When complete press the ignition button to off and click ignition off in the software.

- When complete remove the Harrop-Flash device from the OBD2 port and start the vehicle.

- The vehicle may have an erratic idle briefly while the DME adapts.

## Notes

The Harrop-Flash software can also be used for Diagnostic purposes. If you are required to read diagnostic codes, follow the guide until step 12. At this point you can push diagnostics button and read or clear trouble codes.

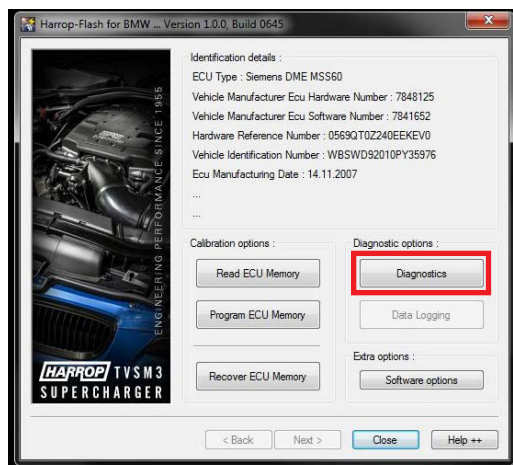

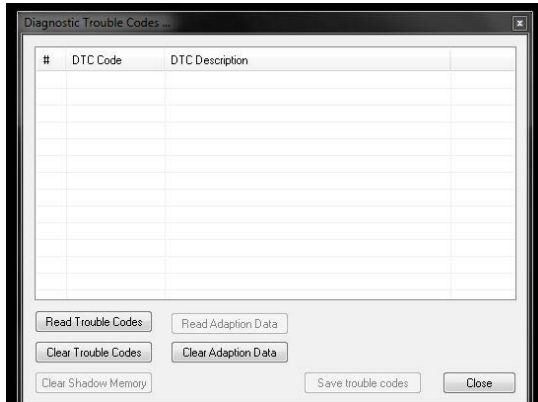

**Note:**

If you have diagnostic codes save them to a text file before clearing so they can be reviewed at a later date.

## How to disable driver signature enforcement on a Win 8 or 8.1 64 bit PC

**BEFORE** installing the Harrop-Flash utility you will need to make some changes to allow the system to install the programmer's USB drivers.

Due to the enforcement by Microsoft Windows 8 64 Bit, drivers that are not digitally signed cannot be installed.

Below are 2 methods of bypassing this enforcement by Microsoft.

The drivers are perfectly safe to use on your PC

Due to the very limited number of people who would use this application, submission to Microsoft for digital signature is not warranted and these instructions are intended for Harrop clients who avail themselves of the flash programming tool for the extensive number of purposes it provides. After completing one of these methods below to reboot your Win 8 PC go ahead and install the Harrop flash program making sure your OBD2 programming tool is plugged in when prompted.

### Option 1

Windows Key + R

Enter the following command (Copy and paste the following command)

```
shutdown.exe /r /o /f /t 0
```

This tells the computer to restart and prompt how you want to start. Click the "OK".

The system will restart to a menu allowing you to change how it boots.

Select "**Troubleshoot**"

Select "**Advanced options**"

Select "**Windows Startup Settings**" – this will restart Windows and let us change the boot options

Click "**Restart**" button

System will restart to "**Advanced Boot Options**" screen

Select “**Disable Driver Signature Enforcement**” – this tells the computer to boot without forcing signed drivers. Reboot the computer and install the device driver as normal (either using the installer if available or Device Manager)

## Option 2

### Open a Command Prompt (Run as Administrator)

On the command prompt type `BCDEDIT /Set LoadOptions DDISABLE_INTEGRITY_CHECKS` and enter. A message will say “Command successful”

Now type `BCDEDIT /Set TESTSIGNING ON`.

If, for any reason, you want to change back to the default, repeat the steps but with the commands

`BCDEDIT /Set LoadOptions DDISABLE_INTEGRITY_CHECKS`  
and `BCDEDIT /Set TESTSIGNING ON`

### Restart the computer.

This changes the driver situation to work like windows 7 and you will still have to allow the unsigned driver to be installed but it won't just automatically cancel the installation.